



Massachusetts
Institute of
Technology



COMET+



Fundamentals of GPS for geodesy

M. Floyd

Massachusetts Institute of Technology

K. Palamartchouk

Newcastle University

GAMIT-GLOBK course
University of Bristol, UK
12–16 January 2015

Material from R. King, T. Herring, M. Floyd (MIT) and S. McClusky (now ANU)

Outline

- GPS observables
- Modeling the observations
- Limits of GPS accuracy
- Time series analysis

Pseudorange

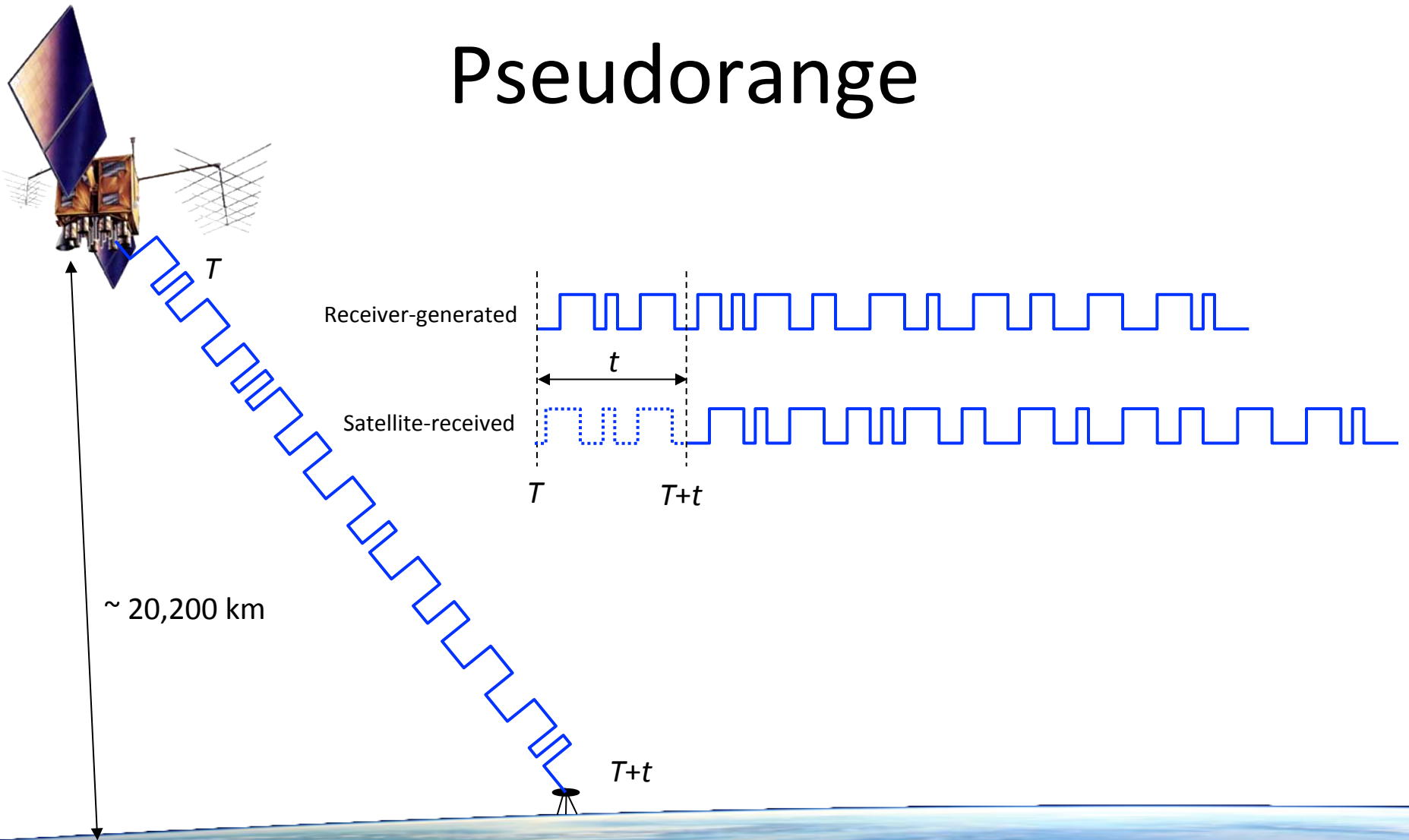

~ 20,200 km

$T+t$

Pseudorange

But...

t is travel time (as measured by clocks in the satellite and receiver), which is subject to error between these clocks.

So...

We need a minimum of *four* satellites in order to solve for an additional unknown, the clock bias.

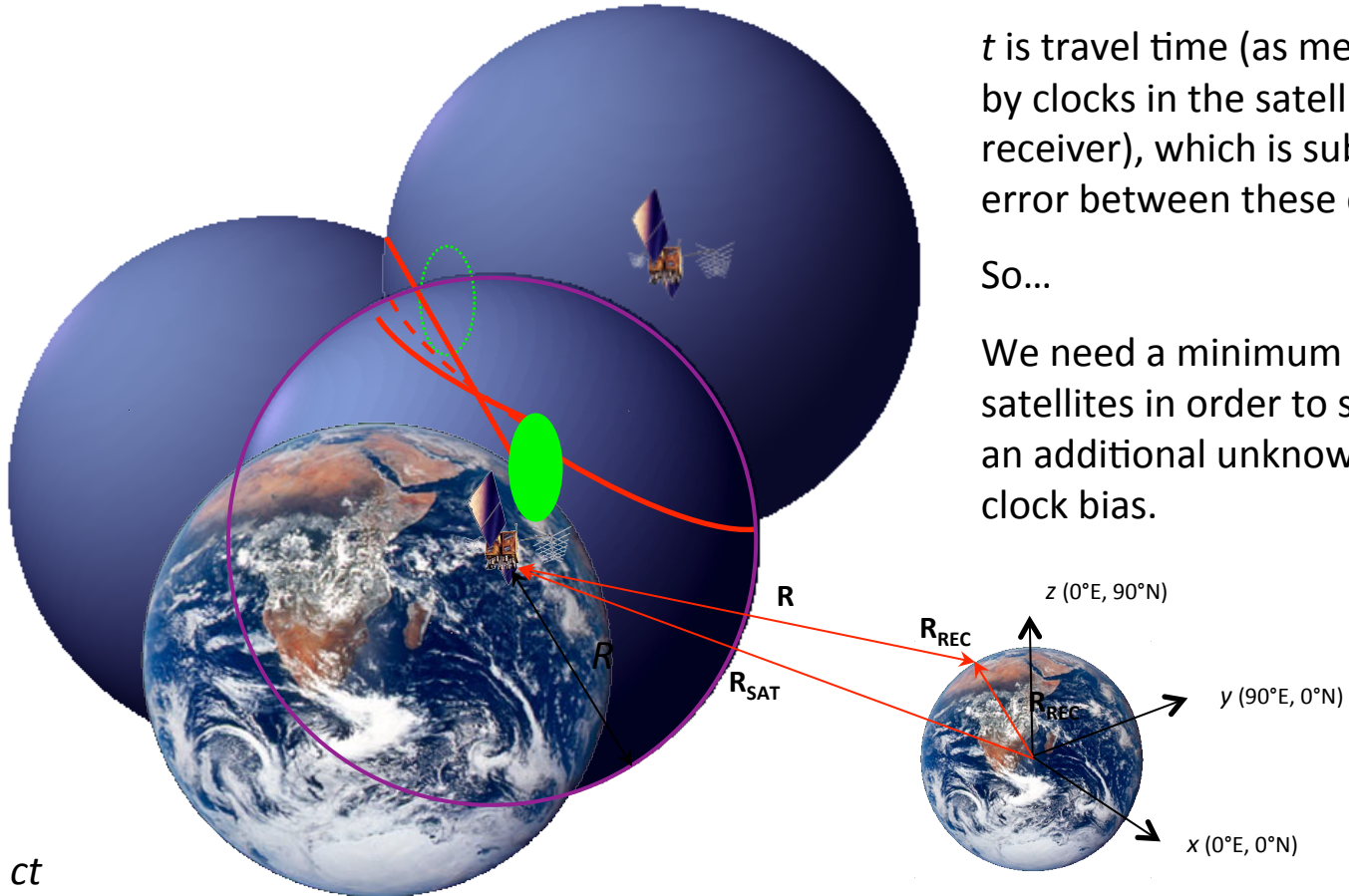

$$R = | \mathbf{R}_{\text{sat}} - \mathbf{R}_{\text{rec}} |$$

$$R = c[(T+t) - T] = ct$$

$$(ct_{\text{sat-rec}})^2 = (x_{\text{sat}_i} - x_{\text{rec}})^2 + (y_{\text{sat}_i} - y_{\text{rec}})^2 + (z_{\text{sat}_i} - z_{\text{rec}})^2$$

Instantaneous Positioning with GPS Pseudoranges

Receiver solution or *sh_rx2apr*

- Point position (*svpos*) 5-100 m
- Differential (*svdiff*) 1-10 m

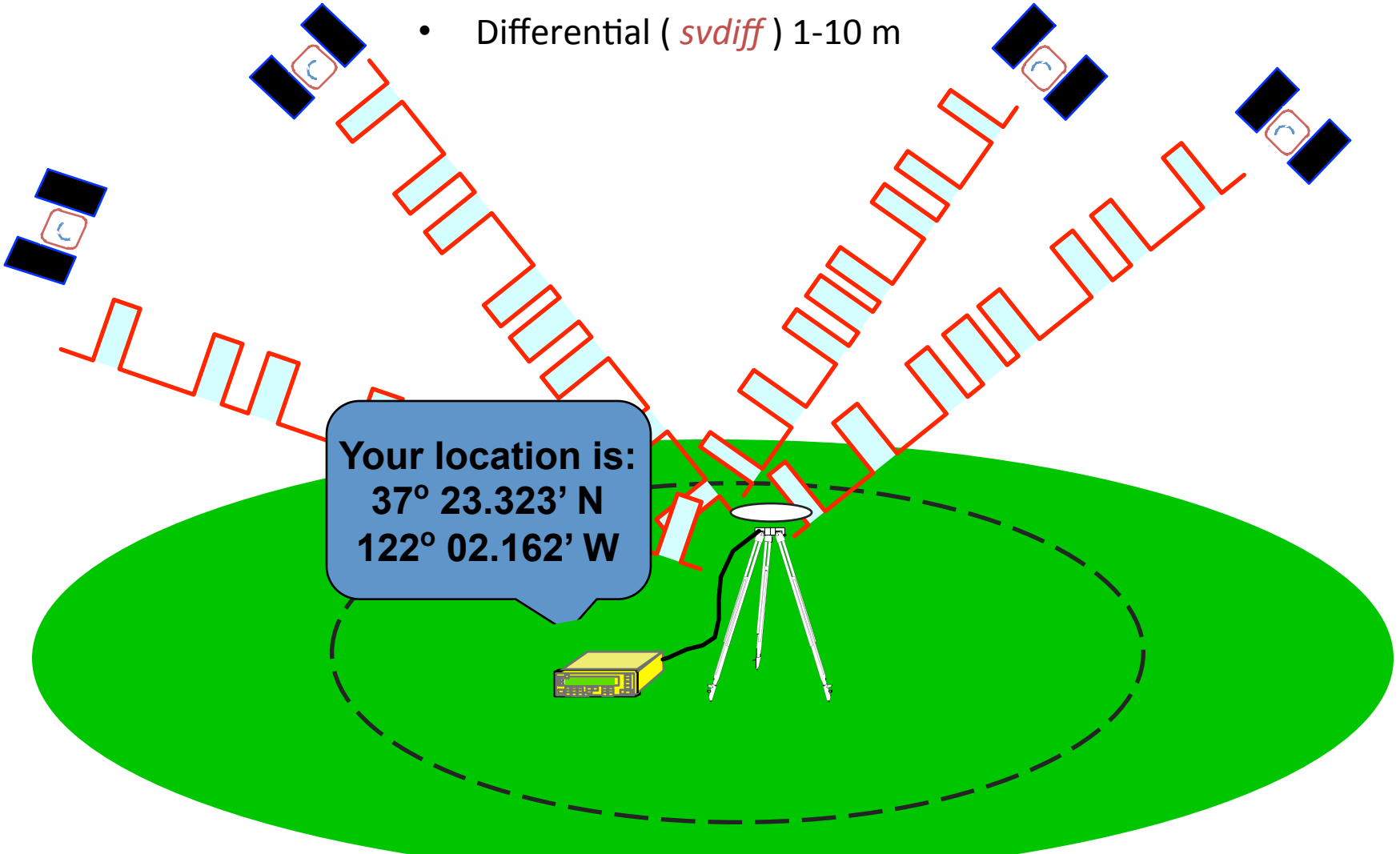

The diagram illustrates the process of instantaneous positioning. It features a green ground plane with a dashed black circle representing the receiver's field of view. A yellow GPS receiver is connected to a white tripod-mounted antenna. Three GPS satellites are shown in the sky, each emitting a signal path (represented by a red zigzag line) towards the ground receiver. A blue speech bubble contains the resulting location coordinates.

Your location is:
37° 23.323' N
122° 02.162' W

Precise positioning using phase measurements

- High-precision positioning uses the phase observations
- Long-session static: change in phase over time carries most of the information
- The shorter the PPP the more important is ambiguity resolution

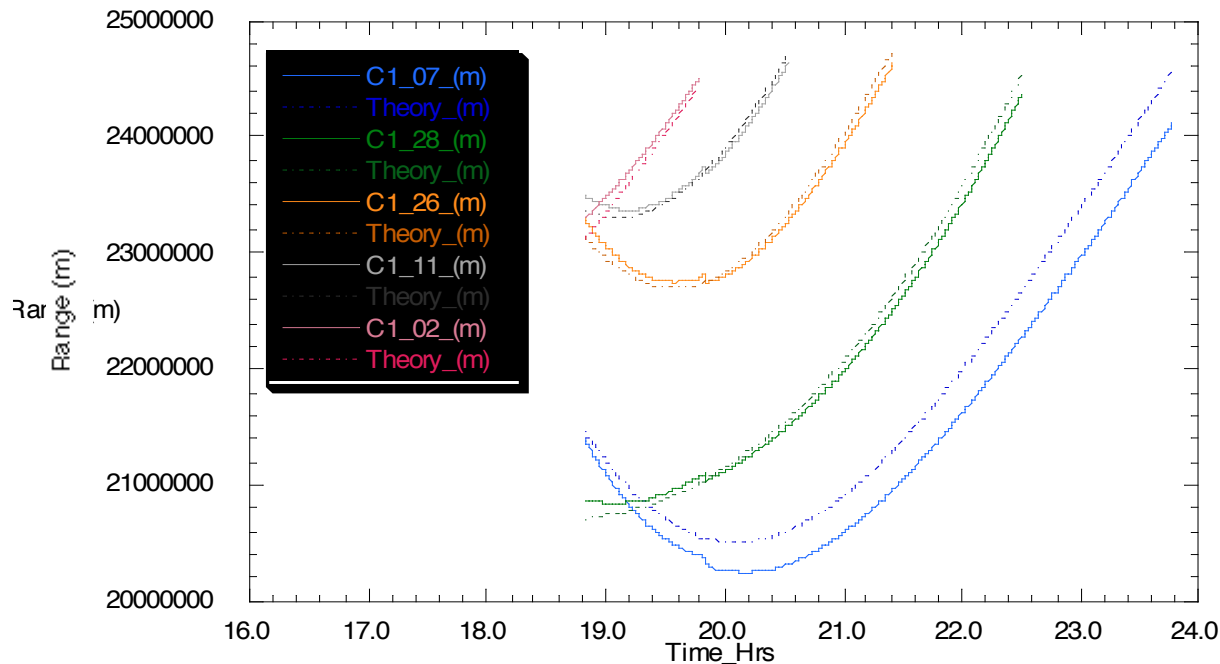

Each Satellite (and station) has a different signature

Observables in Data Processing

Fundamental observations

L1 phase = $f_1 \times \text{range}$ (19 cm) L2 phase = $f_2 \times \text{range}$ (24 cm)

C1 or P1 pseudorange used separately to get receiver clock offset (time)

To estimate parameters use doubly differenced

LC = $2.55 L_1 - 1.98 L_2$ “Ionosphere-free phase combination” L1-cycles

PC = $2.55 P_1 - 1.55 P_2$ “Ionosphere-free range combination” Meters

Double differencing (DD) removes clock fluctuations; LC removes almost all of ionosphere. Both DD and LC amplify noise (use L1, L2 directly for baselines < 1 km)

Auxiliary combinations for data editing and ambiguity resolution

“Geometry-free combination (LG)” or “Extra wide-lane” (EX-WL)

LG = $L_2 - f_2/f_1 L_1$ used in GAMIT

EX-WL = $L_1 - f_1/f_2 L_2$ used in TRACK

Removes all frequency-independent effects (geometric & atmosphere) but not multipath or ionosphere

Melbourne-Wubben wide-Lane (MW-WL): phase/pseudorange combination that removes geometry and ionosphere; dominated by pseudorange noise

MW-WL = $N_1 - N_2 = (L_1 - L_2) - (\Delta F / \Sigma F)(P_1 + P_2) = (L_1 - L_2) - 0.12 (P_1 + P_2)$

Modeling the observations

I. Conceptual/Quantitative

- Motion of the satellites
 - Earth's gravity field (flattening 10 km; higher harmonics 100 m)
 - Attraction of Moon and Sun (100 m)
 - Solar radiation pressure (20 m)
- Motion of the Earth
 - Irregular rotation of the Earth (5 m)
 - Luni-solar solid-Earth tides (30 cm)
 - Loading due to the oceans, atmosphere, and surface water and ice (10 mm)
- Propagation of the signal
 - Neutral atmosphere (dry 6 m; wet 1 m)
 - Ionosphere (10 m but LC corrects to a few mm most of the time)
 - Variations in the phase centers of the ground and satellite antennas (10 cm)

* incompletely modeled

Modeling the observations

II. Software structure

- Satellite orbit
 - IGS tabulated ephemeris (Earth-fixed SP3 file) [track]
 - GAMIT tabulated ephemeris (t-file): numerical integration by arc in inertial space, fit to SP3 file, may be represented by its initial conditions (ICs) and radiation-pressure parameters; requires tabulated positions of Sun and Moon
- Motion of the Earth in inertial space [model or track]
 - Analytical models for precession and nutation (tabulated); IERS observed values for pole position (wobble), and axial rotation (UT1)
 - Analytical model of solid-Earth tides; global grids of ocean and atmospheric tidal loading
- Propagation of the signal [model or track]
 - Zenith hydrostatic (dry) delay (ZHD) from pressure (met-file, VMF1, or GPT)
 - Zenith wet delay (ZWD) [crudely modeled and estimated in solve or track]
 - ZHD and ZWD mapped to line-of-sight with mapping functions (VMF1 grid or GMT)
 - Variations in the phase centers of the ground and satellite antennas (ANTEX file)

Parameter Estimation

- Phase observations [**solve** or **track**]
 - Form double difference LC combination of L1 and L2 to cancel clocks & ionosphere
 - Apply a priori constraints
 - Estimate the coordinates, ZTD, and real-valued ambiguities
 - Form M-W WL and/or phase WL with ionospheric constraints to estimate and resolve the WL (L2-L1) integer ambiguities [**autcln**, **solve**, **track**]
 - Estimate and resolve the narrow-lane (NL) ambiguities
 - Estimate the coordinates and ZTD with WL and NL ambiguities fixed
 - Estimation can be batch least squares [**solve**] or sequential (Kalman filter [**track**])
- Quasi-observations from phase solution (h-file) [**globk**]
 - Sequential (Kalman filter)
 - Epoch-by-epoch test of compatibility (chi2 increment) but batch output

Limits of GPS Accuracy

- Signal propagation effects
 - Signal scattering (antenna phase center / multipath)
 - Atmospheric delay (mainly water vapor)
 - Ionospheric effects
 - Receiver noise
- Unmodeled motions of the station
 - Monument instability
 - Loading of the crust by atmosphere, oceans, and surface water
- Unmodeled motions of the satellites
- Reference frame

Limits of GPS Accuracy

- Signal propagation effects
 - Signal scattering (antenna phase center / multipath)
 - Atmospheric delay (mainly water vapor)
 - Ionospheric effects
 - Receiver noise
- Unmodeled motions of the station
 - Monument instability
 - Loading of the crust by atmosphere, oceans, and surface water
- Unmodeled motions of the satellites
- Reference frame

Multipath is interference between the direct and a far-field reflected signal (geometric optics apply)

To mitigate the effects:

- Avoid Reflective Surfaces
- Use a Ground Plane Antenna
- Avoid near-ground mounts
- Observe for many hours
- Remove with average from many days

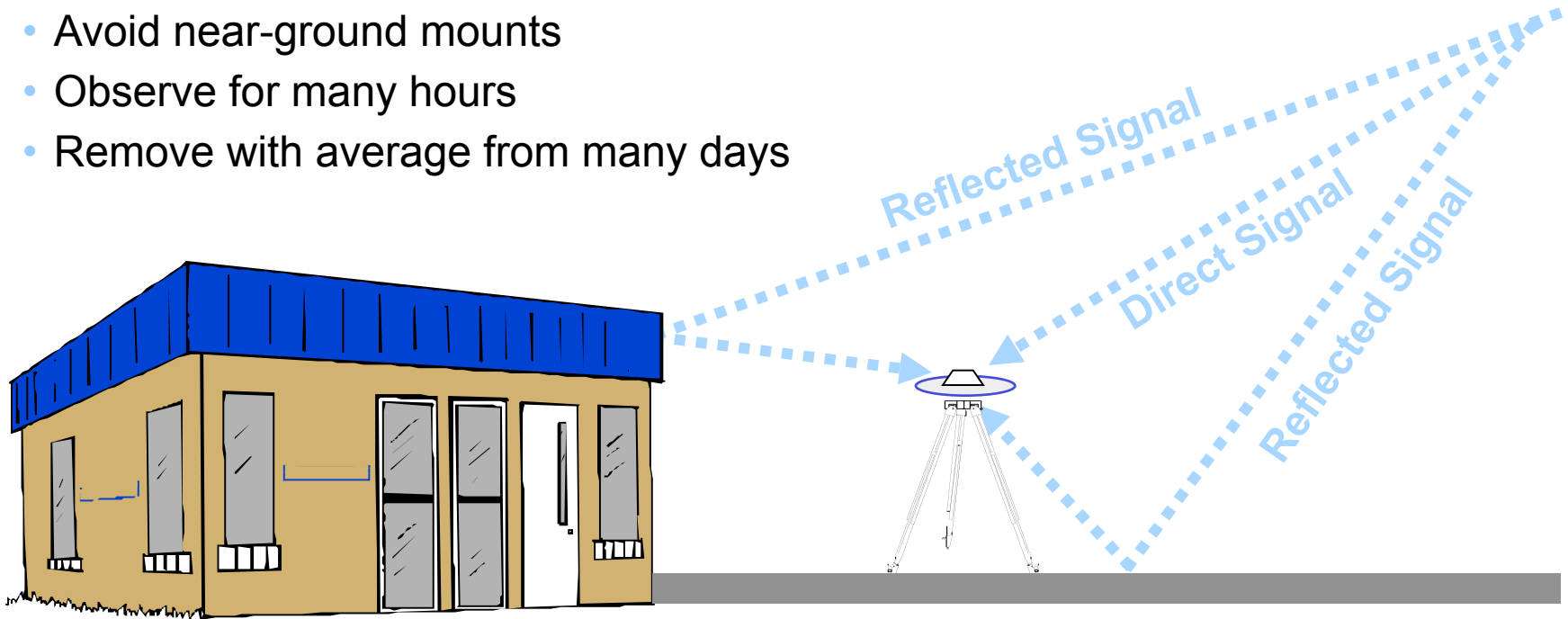

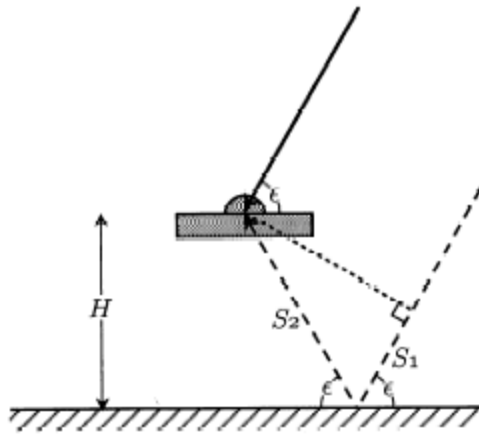

Simple geometry for incidence of a direct and reflected signal

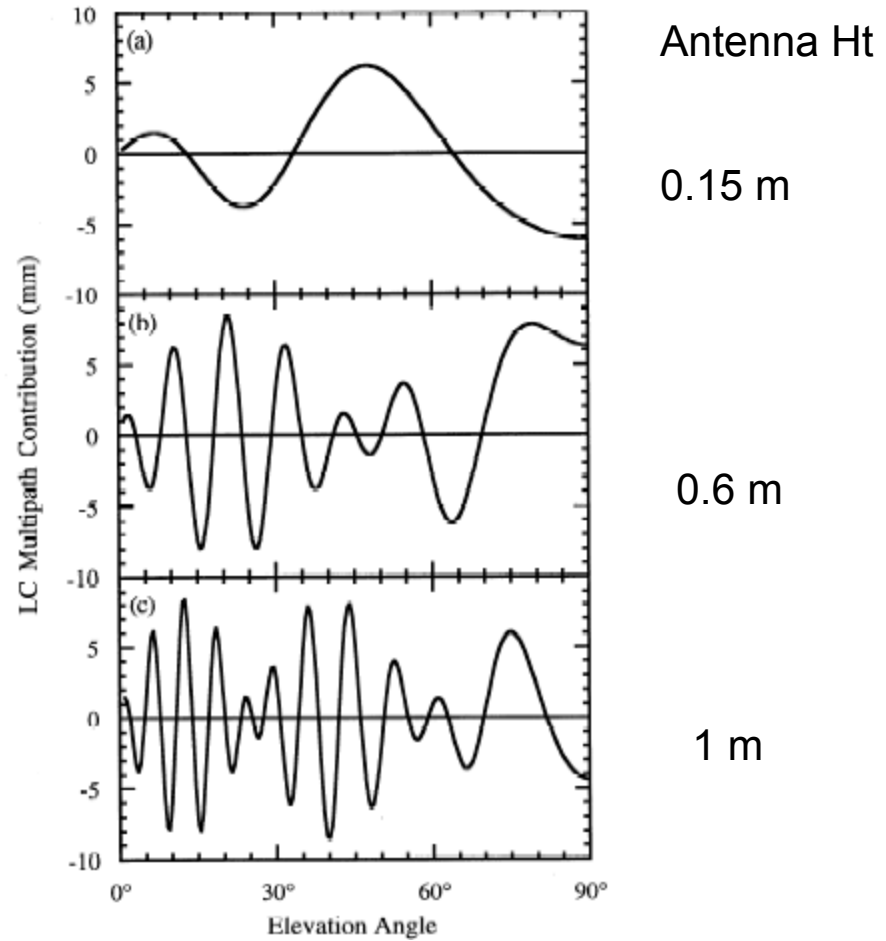

Multipath contributions to observed phase for three different antenna heights [From *Elosegui et al*, 1995]

More dangerous are near-field signal interactions that change the effective antenna phase center with the elevation and azimuth of the incoming signal

Left: Examples of the antenna phase patterns determined in an anechoic chamber...BUT the actual pattern in the field is affected by the antenna mount

To avoid height and ZTD errors of centimeters, we must use at least a nominal model for the phase-center variations (PCVs) for each antenna type

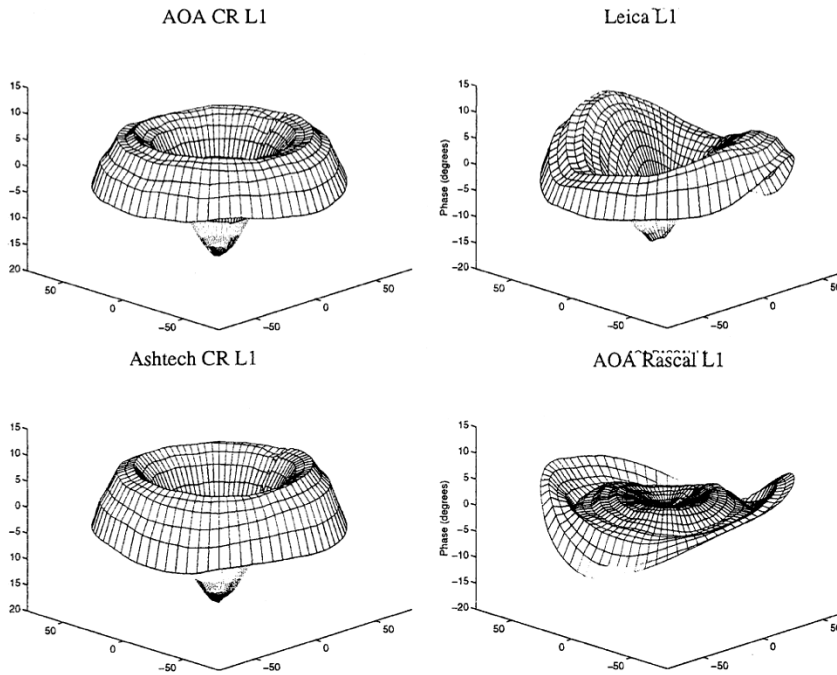

Figures courtesy of UNAVCO

Antenna Phase Patterns

Atmospheric Delay

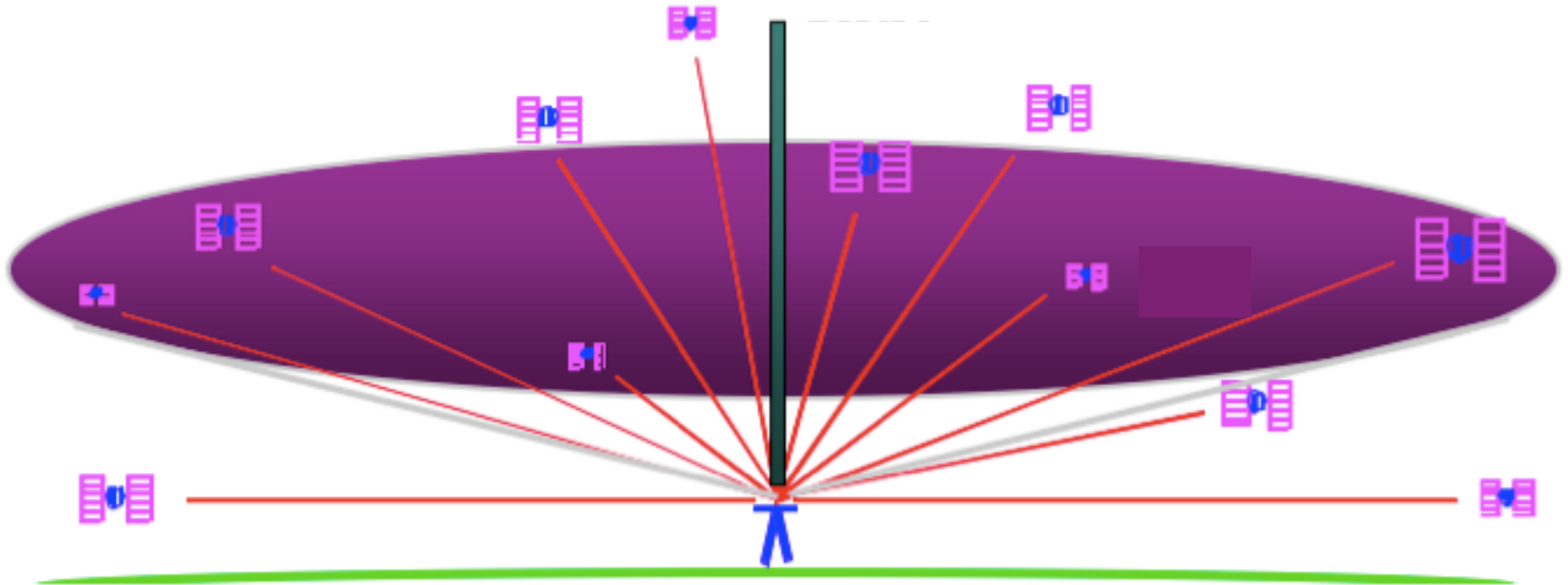

The signal from each GPS satellite is delayed by an amount dependent on the pressure and humidity and its elevation above the horizon. We invert the measurements to estimate the average delay at the zenith (green bar).

(Figure courtesy of COSMIC Program)

Zenith Delay from Wet and Dry Components of the Atmosphere

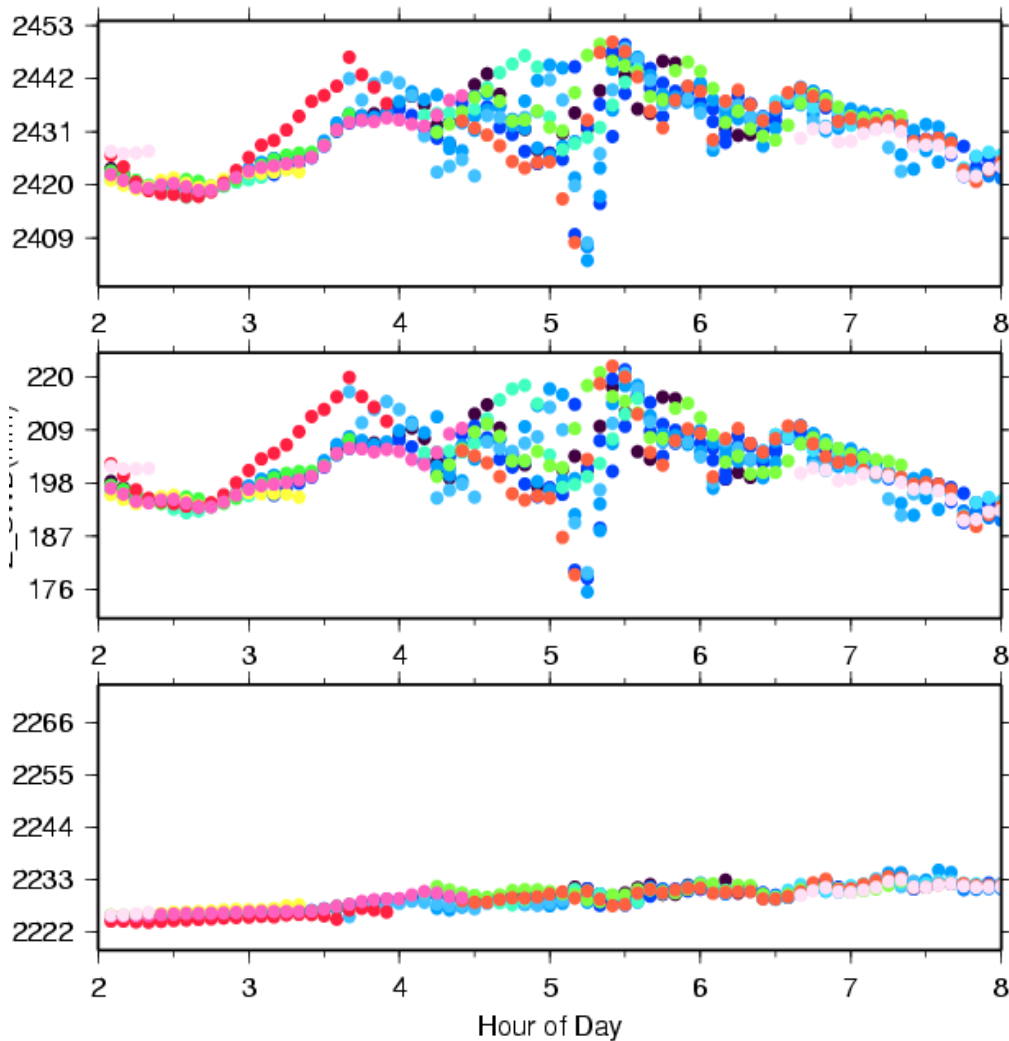

Colors are for different satellites

Total delay is ~2.5 meters
Variability mostly caused by wet component.

Wet delay is ~0.2 meters
Obtained by subtracting the hydrostatic (dry) delay.

Hydrostatic delay is ~2.2 meters; little variability between satellites or over time; well calibrated by surface pressure.

Plot courtesy of J. Braun, UCAR

Multipath and Water Vapor Effects in the Observations

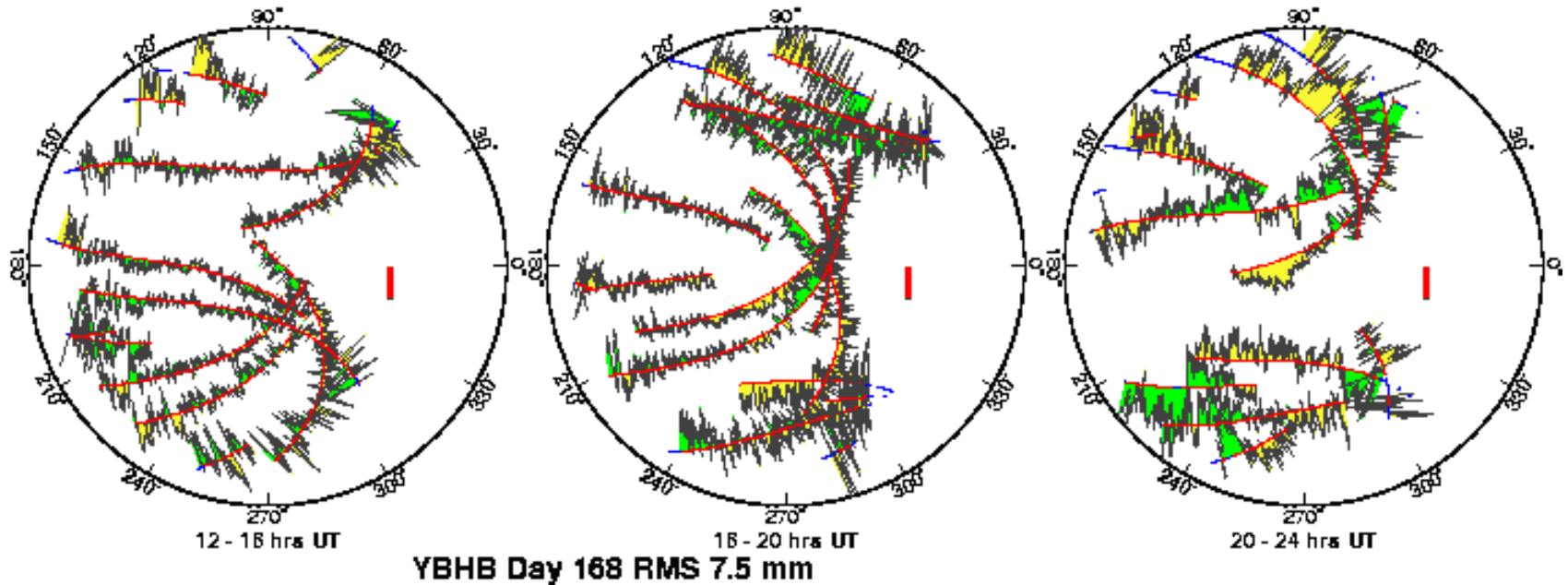

One-way (undifferenced) LC phase residuals projected onto the sky in 4-hr snapshots. Spatially repeatable noise is multipath; time-varying noise is water vapor.

Red is satellite track. Yellow and green positive and negative residuals purely for visual effect. Red bar is scale (10 mm).

Limits of GPS Accuracy

- Signal propagation effects
 - Signal scattering (antenna phase center / multipath)
 - Atmospheric delay (mainly water vapor)
 - Ionospheric effects
 - Receiver noise
- **Unmodeled motions of the station**
 - Monument instability
 - Loading of the crust by atmosphere, oceans, and surface water
- Unmodeled motions of the satellites
- Reference frame

Monuments Anchored to Bedrock are Critical for Tectonic Studies (not so much for atmospheric studies)

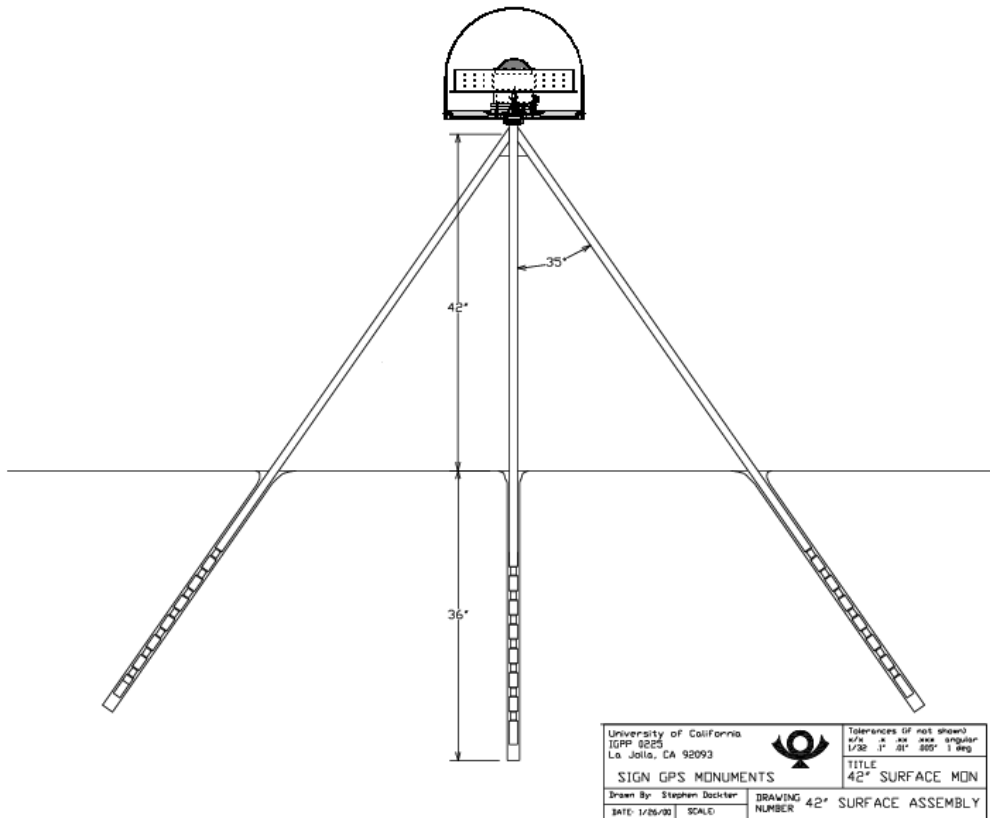

Good anchoring:

Pin in solid rock

Drill-braced (left) in fractured rock

Low building with deep foundation

Not-so-good anchoring:

Vertical rods

Buildings with shallow foundation

Towers or tall building
(thermal effects)

Annual Component of Vertical Loading

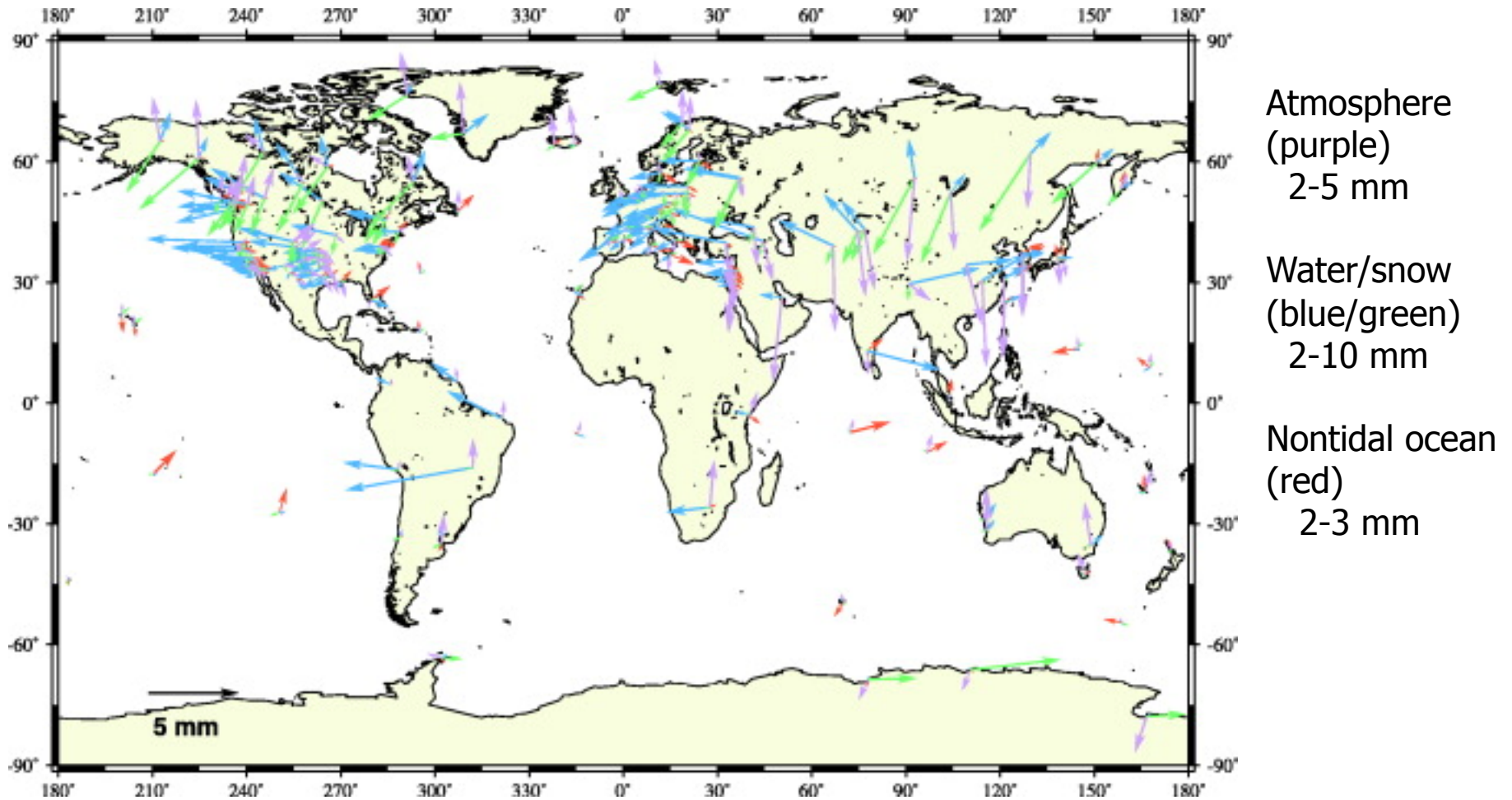

From Dong et al. *J. Geophys. Res.*, 107, 2075, 2002

Limits of GPS Accuracy

- Signal propagation effects
 - Signal scattering (antenna phase center / multipath)
 - Atmospheric delay (mainly water vapor)
 - Ionospheric effects
 - Receiver noise

 - Monument instability
 - Loading of the crust by atmosphere, oceans, and surface water
- **Unmodeled motions of the satellites**
- Reference frame

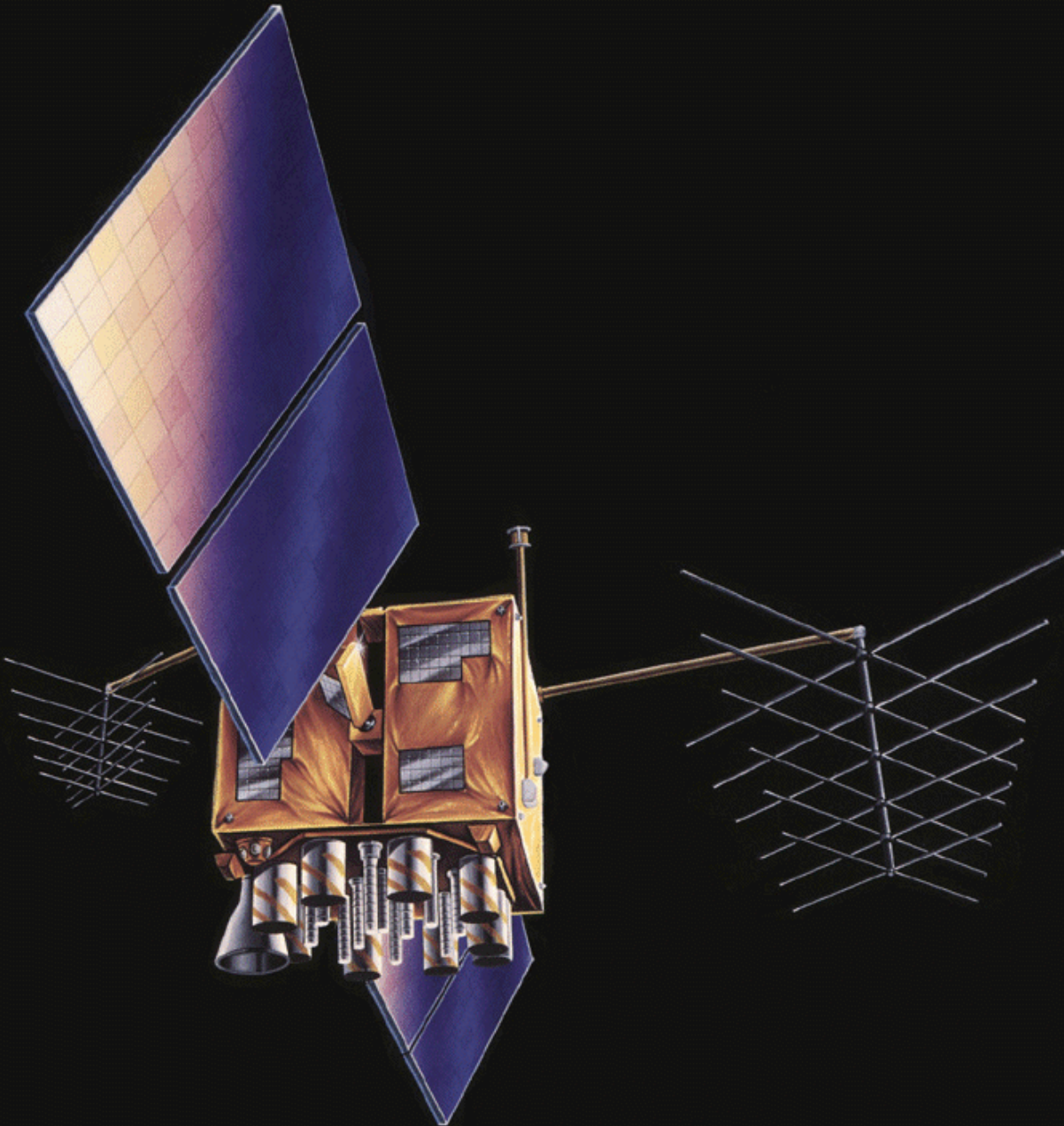

GPS Satellite

Limits to model are non-gravitational accelerations due to solar and Earth radiation, unbalanced thrusts, and outgassing; and non-spherical antenna pattern

Modeling of these effects has improved, but for global analyses remain a problem

Final Orbits (AC solutions compared to IGS Final)

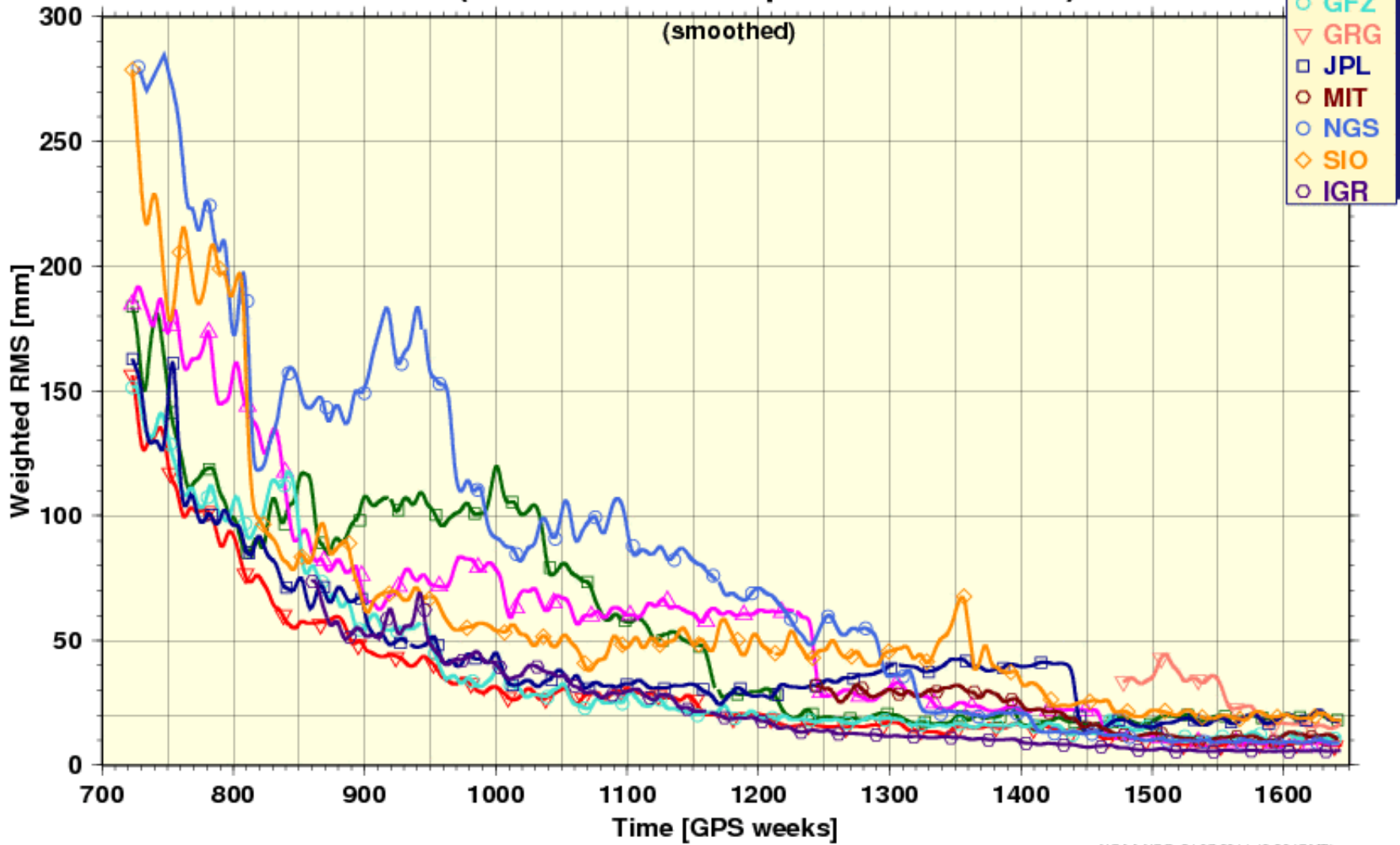

Quality of IGS Final Orbits 1994-2011/07

20 mm = 1 ppb

Source: <http://acc.igs.org>

Limits of GPS Accuracy

- Signal propagation effects
 - Signal scattering (antenna phase center / multipath)
 - Atmospheric delay (mainly water vapor)
 - Ionospheric effects
 - Receiver noise
- Unmodeled motions of the station
 - Monument instability
 - Loading of the crust by atmosphere, oceans, and surface water
- Unmodeled motions of the satellites
- Reference frame

Reference Frames

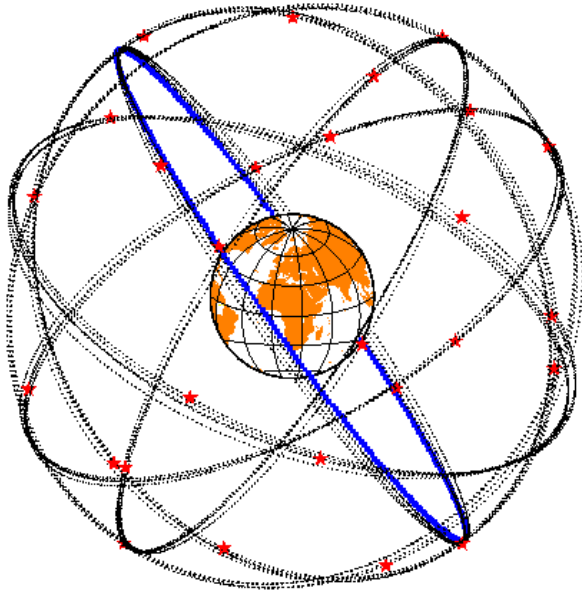

Basic Issue: How well can you relate your position estimates over time to

- 1) a set of stations whose motion is well modeled ;
- 2) a block of crust that allows you to interpret the motions

Implementation: How to use the available data and the features of GLOBK to realize the frame(s)

Both questions to be addressed in detail in later lectures.

Effect of Orbital and Geocentric Position Error/ Uncertainty

High-precision GPS is essentially relative !

Baseline error/uncertainty \sim $\frac{\text{Baseline distance}}{\text{SV altitude}}$ x geocentric SV or position error

SV errors reduced by averaging:

Baseline errors are $\sim 0.2 \bullet$ orbital error / 20,000 km

e.g. 20 mm orbital error = 1 ppb or 1 mm on 1000 km baseline

Network ("absolute") position errors less important for small networks

e.g. 5 mm position error \sim 1 ppb or 1 mm on 1000 km baseline

10 cm position error \sim 20 ppb or 1 mm on 50 km baseline

* But SV and position errors are magnified for short sessions